

Heavy Duty Trench Drain Systems
Pre Cast Concrete Trench Drains
300

P: 646-227-0910

Fiber-Reinforced Trench Drains for All Applications



A heavyweight when it comes to features.

Combines smart engineering and smart materials to provide a superior trench drain suitable for handling a high load capacity. Combining the features of a stable concrete channel with the strength, durability and environmental-friendliness of fiber-reinforced concrete, the ideal choice for a wide variety of sites and applications.

Applications. Because this line can handle a high load capacity, it is especially suitable for installation in industrial areas such as factories, garages and parking lots. With its sleek design it can easily be used in public places like railway stations, and pedestrian or residential areas.

Vertical outlet on every channel.

Every channel body has a vertical outlet possibility.

Engineered channel interior.

The particularly smooth inner surface of channels achieves the best possible flow characteristics and self-cleaning effect.

Sealant groove.

Sealant groove for waterproof installation.



Concrete Trench Drains

- **Temperature, frost and UV resistant.** Less contraction and expansion and longer product life.
- **Product impact stability.** Less susceptible to cracking and breaking during transport and installation.
- **100% recyclable / 0% harmful substances.** Sustainable solution without VOCs or heavy-metal residue that can leach into the ground. Qualifies for LEED credits.
- **Non-flammable.** Manufactured without resins, rated A1, non-combustible.
- **Monolithic adhesion.** Free from de-molding agents, bonds securely with the surrounding concrete.

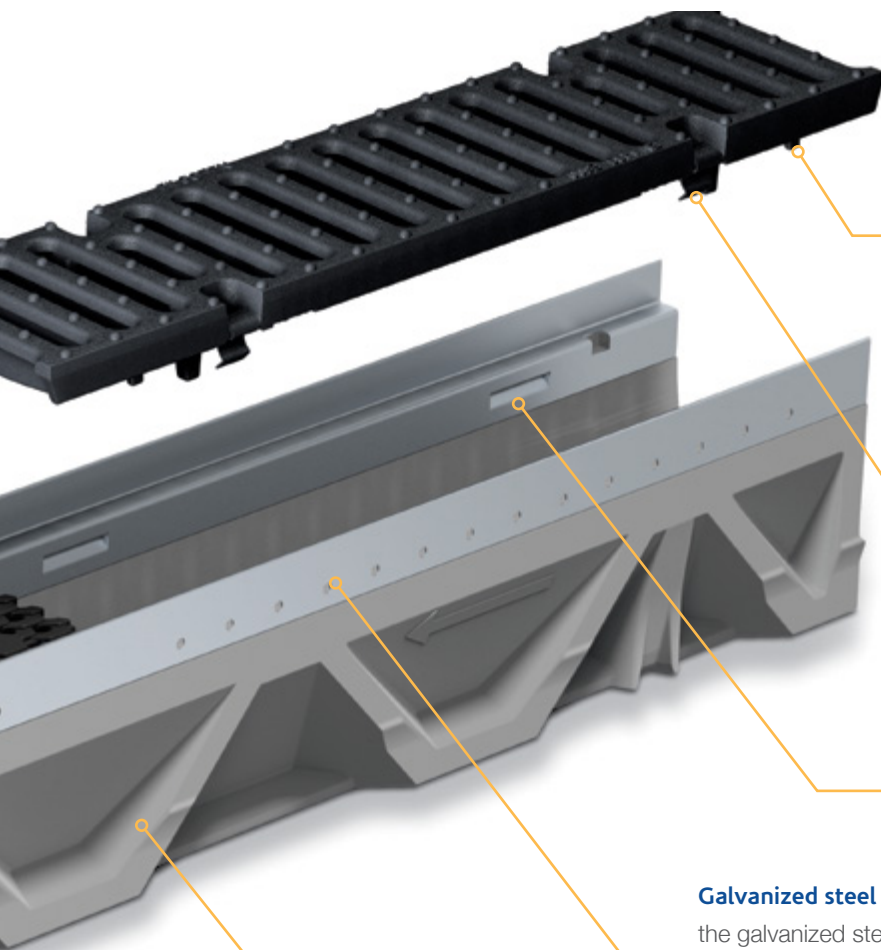

Engineered for stability.

Four anti-sliding lugs secure the grate against any longitudinal shifting and provides additional safety.

Fast and secure fix-connection snap-on-anchoring system.

The intelligent fix-connection uses an amazingly simple four-point, quick-release, integral design to securely hold the grate in place.

Designed with security in mind. Anti-vandal locking devices are available to ensure grates are only removed by authorized personnel. Four locking devices per channel section are recommended.

Galvanized steel rails. The special design of the galvanized steel rails allows for secure grate locking with the fix-connection self-locking system.

Engineered channel exterior. The anchoring ribs have been specially designed to support the channel and increase the exposed surface area, providing far better adhesion to the surrounding concrete.

12" wide 300



300 Galvanized Steel

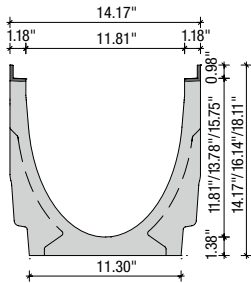

300 Trench Drain

12"/300mm wide channel body with galvanized rail, pre-sloped and neutral sections

Item No.	Product Name	Length (in.)	Height at Channel End (in.)	Weight (lb.)
200	300 Channel 0 with Galvanized Rail - Neutral	39.37	14.17	166.67
201	300 Channel 1 with Galvanized Rail	39.37	14.37	168.21
202	300 Channel 2 with Galvanized Rail	39.37	14.57	171.07
203	300 Channel 3 with Galvanized Rail	39.37	14.76	173.94
204	300 Channel 4 with Galvanized Rail	39.37	14.96	176.81
205	300 Channel 5 with Galvanized Rail	39.37	15.15	179.67
261	300 Channel 5-0 with Galvanized Rail - Neutral	39.37	15.15	181.22
206	300 Channel 6 with Galvanized Rail	39.37	15.35	182.54
207	300 Channel 7 with Galvanized Rail	39.37	15.55	185.41
208	300 Channel 8 with Galvanized Rail	39.37	15.74	188.27
209	300 Channel 9 with Galvanized Rail	39.37	15.94	191.14
210	300 Channel 10 with Galvanized Rail	39.37	16.14	194.01
262	300 Channel 10-0 with Galvanized Rail - Neutral	39.37	16.14	199.08
264	300 Channel 20-0 with Galvanized Rail - Neutral	39.37	18.11	244.05

300 Grates with fix-connection self-locking system & additional 4-point bolting

Item No.	Product Name	Dimensions L / W / H (in.) / (mm)	Load class per EN1433	Max. Design Load (lb.)	Slot/mesh width	Intake Area (in. ² /ft.)
305-GS	300 Galvanized Steel Mesh Grate Class C - 1m	39.37"/13.66"/0.98" 1000/347/25	Class C	56,200	1.18" x 0.39" (30 x 10mm)	108.89
305-GS2	300 Galvanized Steel Mesh Grate Class C - 1/2m	19.69"/13.66"/0.98" 500/347/25	Class C	56,200	1.18" x 0.39" (30 x 10mm)	108.89
305	300 Ductile Iron Longitudinal Bar Grate Class E - 1/2m	19.69"/13.66"/0.98" 500/347/25	Class E	134,800	1.14" x 0.51" (29 x 13mm)	69.21

*Calculated using simple orifice equation with 1/2 inch head

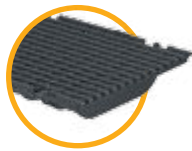

103

300 Accessories

Item No.	Product Name	Material	Weight (lb.)
13	300 Sump Kit with Silt Bucket	Galvanized Steel	7.05
213	300 Closed End Cap	Galvanized Steel	3.75
214	300 End Cap with 8" Outlet	Galvanized Steel	3.53
154	Catch Basin to 8" Pipe Connector	Plastic	2.43
0020	300 Catch Basin Extension Unit	High-Performance Fiber-Reinforced Concrete	93.70
290	End Cap Adapter Plate with Connection Cutouts	Galvanized Steel	0.66
295	300 Step Connector Plate	Galvanized Steel	0.88
290	300 Catch Basin with Galvanized Rail	High-Performance Fiber- Reinforced Concrete	273.37

NOTE: Will accept 8" pipe



300 Sump Kit with Silt Bucket

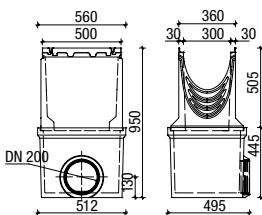

Resources:

Load Ratings according to EN1433 Standards:



CLASS A

- Max Design Load: 3,372 lbs.
- Pedestrians
- Bicyclists
- Planted areas



CLASS B

- Max Design Load: 28,100 lbs.
- Pedestrians
- Parking lots
- Delivery vehicles



CLASS C

- Max Design Load: 56,200 lbs.
- Curbs
- Road shoulders
- Parking lots



CLASS D

- Max Design Load: 89,920 lbs.
- Roadways
- Pedestrian zones
- Parking lots



CLASS E

- Max Design Load: 134,800 lbs.
- Industry
- Military
- High wheel loads

Neutral run

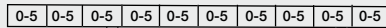

*Any neutral channel can be used in this application.

Linear run without neutrals

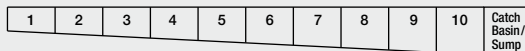

Linear run with neutrals

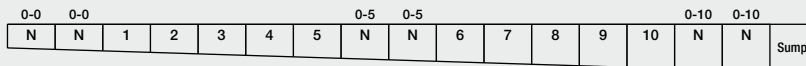
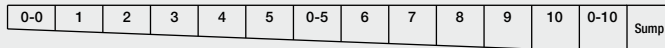

Step Slope



Counter-directional



Note: Drawings are not to scale. See previous pages for actual product dimensions.